

# Fiche technique du produit

Spécifications



## Harmony XB4 - tête bouton tournant à manette - Ø22 - 3 pos rap de D au C - noir

ZB4BD8

Statut commercial: Commercialisé

### Principales

Gamme de produit	Harmony XB4
Type de produit ou équipement	Tête d'interrupteur
Nom de l'appareil	ZB4
Matériau de la collerette	Métal chromé
Diamètre de fixation	22,5 mm
Type de tête	Standard
Vente par quantité indivisible	1
Forme de la tête de l'unité de signalisation	Rond
Type d'unité de commande	Droite au centre rappel à ressort
Profil de l'unité de commande	Noir poignée standard
Positions de l'unité de commande	3 positions +/- 45°
Couleur de la capsule	Noir

### Complémentaires

Largeur hors tout CAO	29 mm
Hauteur hors tout CAO	29 mm
Profondeur hors tout CAO	44 mm
Poids du produit	0,04 kg
Tenue au nettoyage haute pression	7000000 Pa à 55 °C, distance : 0,1 m
Durée de vie mécanique	1000000 cycle
Code de composition électrique	C3 pour <6 contacts à l'aide desimple blocs dans montage avant C4 pour <6 contacts à l'aide desimple et double blocs dans montage avant C5 pour <5 contacts à l'aide desimple blocs dans montage avant C6 pour <5 contacts à l'aide desimple et double blocs dans montage avant C7 pour <4 contacts à l'aide desimple blocs dans montage avant C8 pour <4 contacts à l'aide desimple et double blocs dans montage avant C11 pour <3 contacts à l'aide desimple blocs dans montage avant

Présentation du produit Élément de base

### Environnement

Traitement de protection	TH
Température ambiante de stockage	-40...70 °C
Température ambiante de fonctionnement	-40...70 °C
Catégorie de surtension	Classe I conforming to CEI 60536

Degré de protection IP	IP67 se conformer à IEC 60529 IP69 IP69K
Tenue à l'environnement NEMA	NEMA 13 NEMA 4X
Tenue aux chocs IK	IK06 conforme à CEI 50102
Normes	IEC 60947-1 UL 508 CEI 60947-5-5 CEI 60947-5-4 CEI 60947-5-1 JIS C8201-5-1 CSA C22.2 No 14 JIS C8201-1
Certifications du produit	BV CSA DNV LROS (Lloyds register of shipping) UL listed
Tenue aux vibrations	5 gn (f= 2...500 Hz) conforming to CEI 60068-2-6
Tenue aux chocs mécaniques	30 gn (durée = 18 ms) pour accélération d'une demi-onde sinusoïdale se conformer à CEI 60068-2-27 50 gn (durée = 11 ms) pour accélération d'une demi-onde sinusoïdale se conformer à CEI 60068-2-27

## Emballage

Type d'emballage 1	PCE
Nb produits dans l'emballage 1	1
Hauteur de l'emballage 1	3,500 cm
Largeur de l'emballage 1	5,400 cm
Longueur de l'emballage 1	5,600 cm
Poids de l'emballage 1	45,000 g
Type d'emballage 2	S02
Nb produits dans l'emballage 2	100
Hauteur de l'emballage 2	15,000 cm
Largeur de l'emballage 2	30,000 cm
Longueur de l'emballage 2	40,000 cm
Poids de l'emballage 2	4,742 kg

## Garantie contractuelle

Garantie	18 mois
----------	---------

## Environmental Data

Schneider Electric vise à atteindre le statut de Net Zero d'ici 2050 grâce à des partenariats avec la chaîne logistique, des matériaux à faible impact et une circularité via notre campagne en cours "Use Better, Use Longer, Use Again" pour prolonger la durée de vie des produits et leur recyclabilité.

[Environmental Data expliquées >](#)

### Empreinte environnementale

Empreinte carbone (kg CO2 eq.)	1
--------------------------------	---

Profil environnemental	<a href="#">Profil environnemental du Produit</a>
------------------------	---

### Use Better

#### Matières et Substances

Emballage avec carton recyclé	Non
-------------------------------	-----

Emballage sans plastique	Non
--------------------------	-----

<a href="#">Directive UE RoHS</a>	Conformité proactive (produit hors de la portée juridique de la directive européenne RoHS)
-----------------------------------	--

Règlementation REACH	<a href="#">Déclaration REACH</a>
----------------------	-----------------------------------

### Use Again

#### Réemballer et réusiner

Profil Économie Circulaire	<a href="#">Informations de fin de vie</a>
----------------------------	--

Reprise	No
---------	----

## Dimensions Drawings

### Dimensions

---

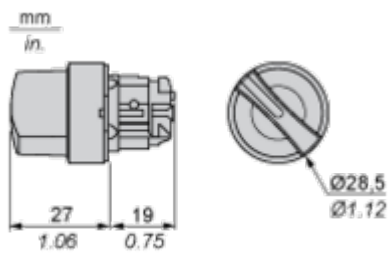

## Mounting and Clearance

### Panel Cut-out for Pushbuttons, Switches and Pilot Lights (Finished Holes, Ready for Installation)

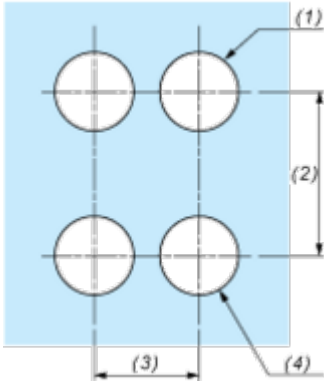
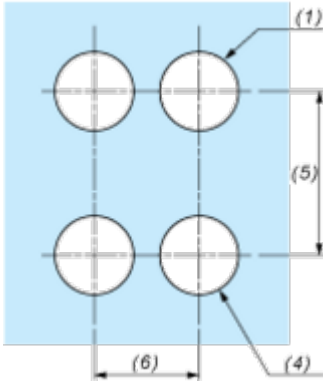
Connection by Screw Clamp Terminals or Plug-in Connectors or on Printed Circuit Board	Connection by Faston Connectors
	
<p>(1) Diameter on finished panel or support</p> <p>(2) 40 mm min. / 1.57 in. min.</p> <p>(3) 30 mm min. / 1.18 in. min.</p> <p>(4) <math>\varnothing 22.5</math> mm / 0.89 in. recommended (<math>\varnothing 22.3</math> mm <math>^{+0.4}_0</math> / 0.88 in. <math>^{+0.016}_0</math>)</p> <p>(5) 45 mm min. / 1.78 in. min.</p> <p>(6) 32 mm min. / 1.26 in. min.</p>	





A: 1.18 in. min.  
 B: 1.57 in. min.

**General Tolerances of the Panel and Printed Circuit Board**

The cumulative tolerance must not exceed 0.3 mm / 0.012 in: T1 + T2 = 0.3 mm max.

**Installation Precautions**

- Minimum thickness of circuit board: 1.6 mm / 0.06 in.
- Cut-out diameter: 22.4 mm ± 0.1 / 0.88 in. ± 0.004
- Orientation of body/fixing collar ZB4 BZ009: ± 2° 30' (excluding cut-outs marked a and b).
- Tightening torque of screws ZBZ 006: 0.6 N.m (5.3 lbf.in) max.
- Allow for one ZB4 BZ079 fixing collar/pillar and its fixing screws:
  - every 90 mm / 3.54 in. horizontally (X), and 120 mm / 4.72 in. vertically (Y).
  - with each selector switch head (ZB4 BD\*, ZB4 BJ\*, ZB4 BG\*).

The fixing centers marked a and b are diagonally opposed and must align with those marked 4 and 5.

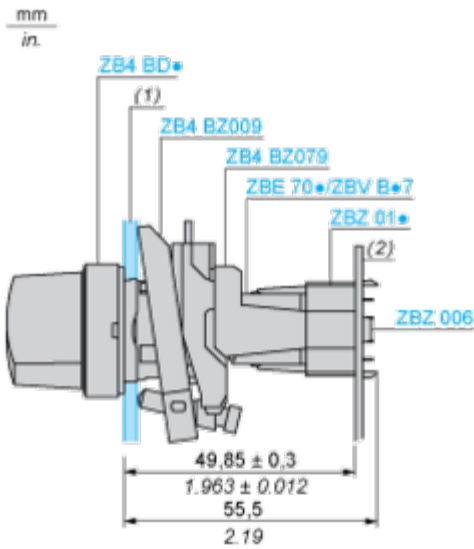

(1) Panel

(2) Printed circuit board

### Mounting of Adapter (Socket) ZBZ 01•

- 1 2 elongated holes for ZBZ 006 screw access
- 2 1 hole  $\varnothing 2.4 \text{ mm} \pm 0.05 / 0.09 \text{ in.} \pm 0.002$  for centring adapter ZBZ 01•
- 3  $8 \times \varnothing 1.2 \text{ mm} / 0.05 \text{ in.}$  holes
- 4 1 hole  $\varnothing 2.9 \text{ mm} \pm 0.05 / 0.11 \text{ in.} \pm 0.002$ , for aligning the printed circuit board (with cut-out marked a)
- 5 1 elongated hole for aligning the printed circuit board (with cut-out marked b)
- 6 4 holes  $\varnothing 2.4 \text{ mm} / 0.09 \text{ in.}$  for clipping in adapter ZBZ 01•

Dimensions An + 18.1 relate to the  $\varnothing 2.4 \text{ mm} \pm 0.05 / 0.09 \text{ in.} \pm 0.002$  holes for centring adapter ZBZ 01•.

Technical Description

**Electrical Composition Corresponding to Code C3**

---

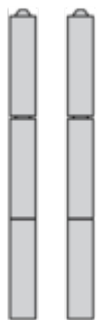

Electrical Composition Corresponding to Code C4

---



Electrical Composition Corresponding to Code C5

---

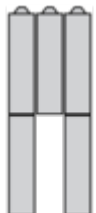

Electrical Composition Corresponding to Code C6

---



Electrical Composition Corresponding to Code C7

---



Electrical Composition Corresponding to Code C8

---

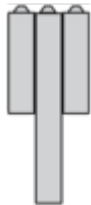

Electrical Composition Corresponding to Codes C9, C11, SF1 and SR1



## Legend

---

Single contact



Double contact



Light block



Possible location



## Sequence of Contacts Fitted to 3-position Selector Switch Body

### Position 315°



<b>Push</b>	Position	Top			
		Bottom			
	Location		Left	Centre	Right
	State		1	1	0
<b>Contacts</b>	N/O		closed	closed	open
	N/C		open	open	closed

### Position 0°



<b>Push</b>	Position	Top			
		Bottom			
	Location		Left	Centre	Right
	State		0	0	0
<b>Contacts</b>	N/O		open	open	open
	N/C		closed	closed	closed

### Position 45°



Push	Position	Top			
		Bottom			
	Location		Left	Centre	Right
	State		0	1	1
Contacts	N/O		open	closed	closed
	N/C		closed	open	open

## Technical Illustration

### Dimensions

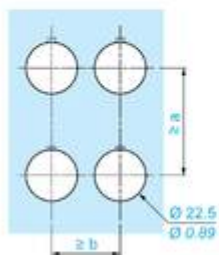
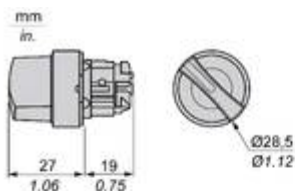

		a (mm)	a (in.)	b (mm)	b (in.)
		40	1.57	30	1.18
ZBE.....	ZBV.....				
		45	1.77	32	1.26
ZBE.....3	ZBV.....3				
		40	1.57	30	1.18
ZBE.....4	ZBV.....4				
		50	1.97	30	1.18
ZBE.....5	ZBV.....5				
		40	1.57	30	1.18
ZBE.....9	ZBV.....9				
		40	1.57	30	1.18
ZBRT...	ZBRV1				

Offer Marketing Illustration

Product benefits / Features

---

## Technical Benefits

### Harmony XB4

Conformity with IEC, UL, CSA, CCC EAC, and JIS standards, as well as CE marking and marine approvals

Up to IP66, 67, 69, 69K, and type 4X protection ratings

High vibration resistance with shake-proof terminal screws



Offer Marketing Illustration

## Product benefits / Features

---

**Features**  
Harmony XB4

- Quick and easy assembly and disassembly
- Excellent mechanical connection with operator head
- Various types of connection: screw clamp, connector, Faston connector, spring terminal, or printed circuit board
- Large set of accessories to customize your panels
- Robustness to withstand harsh environments

Image of product / Alternate images

Alternative

---

