

# Fiche technique du produit

Spécifications



## Harmony XB4 - tête bouton tournant à clé 3131A - Ø22 - 2 pos fix - retr G

ZB4BG220

Statut commercial: Commercialisé

### Principales

Gamme de produit	Harmony XB4
Type de produit ou équipement	Tête d'interrupteur à clé
Nom de l'appareil	ZB4
Matériau de la collerette	Métal chromé
Diamètre de fixation	22 mm
Type de tête	Standard
Vente par quantité indivisible	1
Forme de la tête de l'unité de signalisation	Rond
Profil de l'unité de commande	Noir bouton-tournant à clé
Positions de l'unité de commande	2 positions 90°
Type de verrouillage	Clé 3131A
Position de retrait de la clé	À gauche

### Complémentaires

Largeur hors tout CAO	29 mm
Hauteur hors tout CAO	29 mm
Profondeur hors tout CAO	72 mm
Poids du produit	0,098 kg
Tenue au nettoyage haute pression	7000000 Pa à 55 °C, distance : 0,1 m
Durée de vie mécanique	1000000 cycle
Code de composition électrique	C3 pour <6 contacts à l'aide desimple blocs dans montage avant C4 pour <6 contacts à l'aide desimple et double blocs dans montage avant C5 pour <5 contacts à l'aide desimple blocs dans montage avant C6 pour <5 contacts à l'aide desimple et double blocs dans montage avant C7 pour <4 contacts à l'aide desimple blocs dans montage avant C8 pour <4 contacts à l'aide desimple et double blocs dans montage avant C11 pour <3 contacts à l'aide desimple blocs dans montage avant C15 pour <1 contacts à l'aide desimple blocs dans montage avant
Présentation du produit	Élément de base

### Environnement

Traitement de protection	TH
Température ambiante de stockage	-40...70 °C
Température ambiante de fonctionnement	-40...70 °C

<b>Catégorie de surtension</b>	Classe I conforming to CEI 60536
<b>Degré de protection IP</b>	IP66 se conformer à IEC 60529 IP67 IP69 IP69K
<b>Tenue à l'environnement NEMA</b>	NEMA 13 NEMA 4X
<b>Normes</b>	GB 14048.5 EN/CEI 60947-5-4 EN/CEI 60947-1 UL 508 EN/CEI 60947-5-5 CSA C22.2 No 14 EN/CEI 60947-5-1
<b>Certifications du produit</b>	CSA DNV BV LROS (Lloyds register of shipping) UL listed
<b>Tenue aux vibrations</b>	5 gn (f= 2...500 Hz) conforming to CEI 60068-2-6
<b>Tenue aux chocs mécaniques</b>	30 gn (durée = 18 ms) pour accélération d'une demi-onde sinusoïdale se conformer à CEI 60068-2-27 50 gn (durée = 11 ms) pour accélération d'une demi-onde sinusoïdale se conformer à CEI 60068-2-27

## Emballage

<b>Type d'emballage 1</b>	PCE
<b>Nb produits dans l'emballage 1</b>	1
<b>Hauteur de l'emballage 1</b>	8,600 cm
<b>Largeur de l'emballage 1</b>	5,200 cm
<b>Longueur de l'emballage 1</b>	3,300 cm
<b>Poids de l'emballage 1</b>	105,000 g
<b>Type d'emballage 2</b>	S03
<b>Nb produits dans l'emballage 2</b>	100
<b>Hauteur de l'emballage 2</b>	30,000 cm
<b>Largeur de l'emballage 2</b>	30,000 cm
<b>Longueur de l'emballage 2</b>	40,000 cm
<b>Poids de l'emballage 2</b>	10,851 kg

## Garantie contractuelle

<b>Garantie</b>	18 mois
-----------------	---------

## Environmental Data

Schneider Electric vise à atteindre le statut de Net Zero d'ici 2050 grâce à des partenariats avec la chaîne logistique, des matériaux à faible impact et une circularité via notre campagne en cours "Use Better, Use Longer, Use Again" pour prolonger la durée de vie des produits et leur recyclabilité.

[Environmental Data expliquées >](#)

### Empreinte environnementale

Empreinte carbone (kg CO2 eq.) 1

Profil environnemental [Profil environnemental du Produit](#)

### Use Better

#### Matières et Substances

Emballage avec carton recyclé Non

Emballage sans plastique Non

[Directive UE RoHS](#) Conformité proactive (produit hors de la portée juridique de la directive européenne RoHS)

Numéro SCIP F28cb399-1b6a-409d-ac7b-4169e47b25c8

Réglementation REACH [Déclaration REACH](#)

### Use Again

#### Réemballer et réutiliser

Profil Économie Circulaire [Informations de fin de vie](#)

Reprise No

Dimensions Drawings

## Dimensions

---



## Mounting and Clearance

### Panel Cut-out for Pushbuttons, Switches and Pilot Lights (Finished Holes, Ready for Installation)

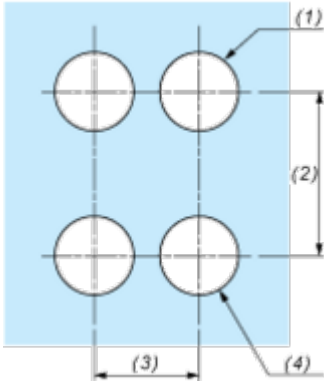
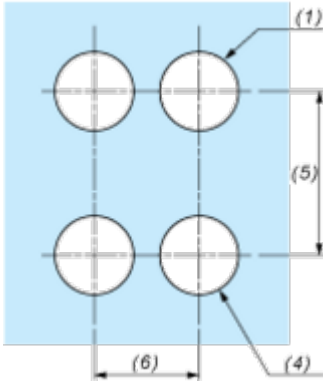
Connection by Screw Clamp Terminals or Plug-in Connectors or on Printed Circuit Board	Connection by Faston Connectors
	
<p>(1) Diameter on finished panel or support</p> <p>(2) 40 mm min. / 1.57 in. min.</p> <p>(3) 30 mm min. / 1.18 in. min.</p> <p>(4) <math>\varnothing 22.5 \text{ mm} / 0.89 \text{ in.}</math> recommended (<math>\varnothing 22.3 \text{ mm} \begin{smallmatrix} +0.4 \\ 0 \end{smallmatrix} / 0.88 \text{ in.} \begin{smallmatrix} +0.016 \\ 0 \end{smallmatrix}</math>)</p> <p>(5) 45 mm min. / 1.78 in. min.</p> <p>(6) 32 mm min. / 1.26 in. min.</p>	

## Pushbuttons, Switches and Pilot Lights for Printed Circuit Board Connection

### Panel Cut-outs (Viewed from Installer's Side)



A: 30 mm min. / 1.18 in. min.

B: 40 mm min. / 1.57 in. min.

### Printed Circuit Board Cut-outs (Viewed from Electrical Block Side)

Dimensions in mm



A: 30 mm min.

B: 40 mm min.

Dimensions in in.

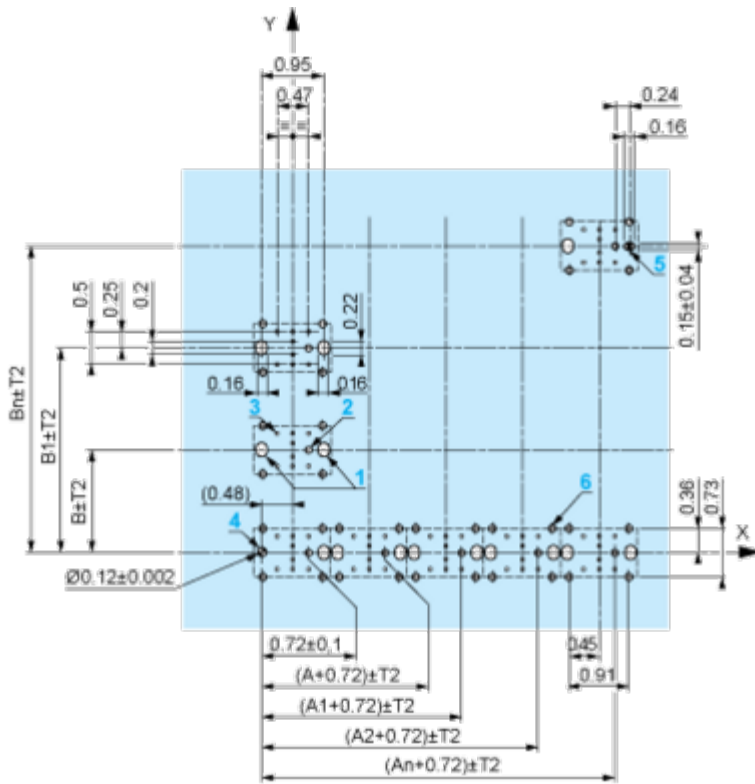

A: 1.18 in. min.  
 B: 1.57 in. min.

**General Tolerances of the Panel and Printed Circuit Board**

The cumulative tolerance must not exceed 0.3 mm / 0.012 in: T1 + T2 = 0.3 mm max.

**Installation Precautions**

- Minimum thickness of circuit board: 1.6 mm / 0.06 in.
- Cut-out diameter: 22.4 mm ± 0.1 / 0.88 in. ± 0.004
- Orientation of body/fixing collar ZB4 BZ009: ± 2° 30' (excluding cut-outs marked a and b).
- Tightening torque of screws ZBZ 006: 0.6 N.m (5.3 lbf.in) max.
- Allow for one ZB4 BZ079 fixing collar/pillar and its fixing screws:
  - every 90 mm / 3.54 in. horizontally (X), and 120 mm / 4.72 in. vertically (Y).
  - with each selector switch head (ZB4 BD\*, ZB4 BJ\*, ZB4 BG\*).

The fixing centers marked a and b are diagonally opposed and must align with those marked 4 and 5.

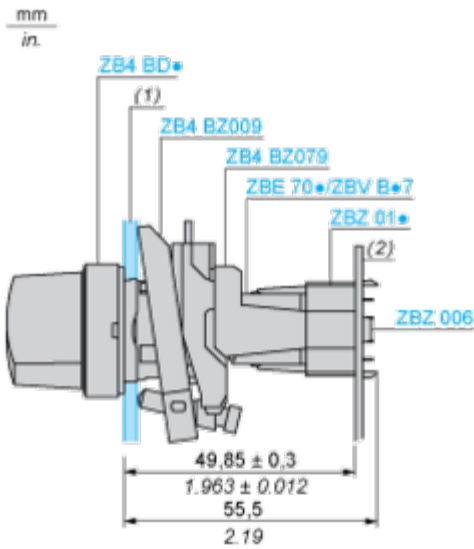

(1) Panel

(2) Printed circuit board

## Mounting of Adapter (Socket) ZBZ 01•

- 1 2 elongated holes for ZBZ 006 screw access
- 2 1 hole  $\varnothing 2.4 \text{ mm} \pm 0.05 / 0.09 \text{ in.} \pm 0.002$  for centring adapter ZBZ 01•
- 3  $8 \times \varnothing 1.2 \text{ mm} / 0.05 \text{ in.}$  holes
- 4 1 hole  $\varnothing 2.9 \text{ mm} \pm 0.05 / 0.11 \text{ in.} \pm 0.002$ , for aligning the printed circuit board (with cut-out marked a)
- 5 1 elongated hole for aligning the printed circuit board (with cut-out marked b)
- 6 4 holes  $\varnothing 2.4 \text{ mm} / 0.09 \text{ in.}$  for clipping in adapter ZBZ 01•

Dimensions An + 18.1 relate to the  $\varnothing 2.4 \text{ mm} \pm 0.05 / 0.09 \text{ in.} \pm 0.002$  holes for centring adapter ZBZ 01•.

Technical Description

Electrical Composition Corresponding to Code C3

---



Electrical Composition Corresponding to Code C4

---



Electrical Composition Corresponding to Code C5

---

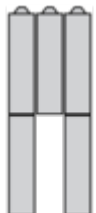

Electrical Composition Corresponding to Code C6

---



Electrical Composition Corresponding to Code C7

---



Electrical Composition Corresponding to Code C8

---

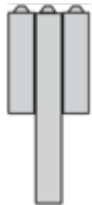

Electrical Composition Corresponding to Codes C9, C11, SF1 and SR1

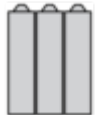

Electrical Composition Corresponding to Code C15

---

1 N/O

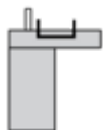

1 N/C

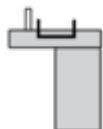

1 N/O + N/C or 1 N/O + N/O or 1 N/C + N/C

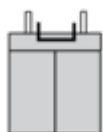

## Legend

---

Single contact



Double contact



Light block







Possible location



## Sequence of Contacts Fitted to 2-position Selector Switch Body

### Position 315°



<b>Push</b>	Position	Top			
		Bottom			
	Location		Left	Centre	Right
	State		0	0	0
	<b>Contacts</b>		N/O	open	open
		N/C	closed	closed	closed

### Position 45°



<b>Push</b>	Position	Top			
		Bottom			
	Location		Left	Centre	Right
	State		1	1	1
	<b>Contacts</b>		N/O	closed	closed
		N/C	open	open	open

## Technical Illustration

### Dimensions

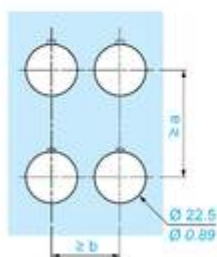
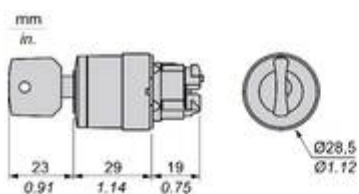

	a (mm)	a (in.)	b (mm)	b (in.)
ZBE..... ZBV.....	40	1.57	30	1.18
ZBE.....3 ZBV.....3	45	1.77	32	1.26
ZBE.....4 ZBV.....4	40	1.57	30	1.18
ZBE.....5 ZBV.....5	50	1.97	30	1.18
ZBE.....9 ZBV.....9	40	1.57	30	1.18
ZBRT... ZBRV1	40	1.57	30	1.18

Offer Marketing Illustration

Product benefits / Features

---

## Technical Benefits

### Harmony XB4

Conformity with IEC, UL, CSA, CCC EAC, and JIS standards, as well as CE marking and marine approvals

Up to IP66, 67, 69, 69K, and type 4X protection ratings

High vibration resistance with shake-proof terminal screws



Operating temperature from -40°C to 70°C

Shock protection level up to IK06

Secure switching of inductive or heavy DC loads directly – 100 000 operations at 10A, 24V dc

Offer Marketing Illustration

## Product benefits / Features

---

**Features**  
Harmony XB4





-  Quick and easy assembly and disassembly
-  Excellent mechanical connection with operator head
-  Various types of connection: screw clamp, connector, Faston connector, spring terminal, or printed circuit board
-  Large set of accessories to customize your panels
-  Robustness to withstand harsh environments

Image of product / Alternate images

Alternative

---

