

# Fiche technique du produit

Spécifications



## Harmony XB4 - tête bouton arrêt urgence - Ø40 - à clé 455 - rouge

ZB4BS944

Statut commercial: Commercialisé

### Principales

Gamme de produit	Harmony XB4
Type de produit ou équipement	Tête de coupure d'urgence
Nom de l'appareil	ZB4
Matériau de la collerette	Métal chromé
Diamètre de fixation	22,5 mm
Vente par quantité indivisible	1
Forme de la tête de l'unité de signalisation	Rond
Type d'unité de commande	déclenchement et accrochage mécanique
Remise à zéro	Déverrouillage par clé
Profil de l'unité de commande	Rouge coup de poing Ø 40 mm, sans marquage
Type de verrouillage	Clé 455
Position de retrait de la clé	Centre
Type de tête	Standard
Couleur de la capsule	Rouge

### Complémentaires

Largeur hors tout CAO	40 mm
Hauteur hors tout CAO	40 mm
Profondeur hors tout CAO	79 mm
Poids du produit	0,098 kg
Tenue au nettoyage haute pression	7000000 Pa à 55 °C, distance : 0,1 m
Durée de vie mécanique	300000 cycle
Code de composition électrique	C7 pour <4 contacts à l'aide desimple blocs dans montage avant C8 pour <4 contacts à l'aide desimple et double blocs dans montage avant C11 pour <3 contacts à l'aide desimple blocs dans montage avant C15 pour <1 contacts à l'aide desimple blocs dans montage avant C10 pour <4 contacts à l'aide desimple et double blocs dans montage avant
Présentation du produit	Élément de base

### Environnement

Traitement de protection	TH
Température ambiante de stockage	-40...70 °C
Température ambiante de fonctionnement	-40...70 °C

<b>Classe de protection contre les chocs électriques</b>	Classe I se conformer à CEI 61140
<b>Degré de protection IP</b>	IP66 se conformer à IEC 60529 IP67 IP69 IP69K
<b>Tenue à l'environnement NEMA</b>	NEMA 13 NEMA 4X NEMA 4 NEMA 12
<b>Tenue aux chocs IK</b>	IK03 conforme à CEI 50102
<b>Normes</b>	CSA C22.2 No 14 CEI 60204-1 IEC 60947-1 GB 14048.5 CEI 60947-5-1 ISO 13850 CEI 60947-5-5 JIS C8201-5-1 CEI 60947-5-4 UL 508 CEI 60364-5-53 JIS C8201-1
<b>Certifications du produit</b>	DNV UL listed LROS (Lloyds register of shipping) BV CSA
<b>Tenue aux vibrations</b>	5 gn (f= 2...500 Hz) conforming to CEI 60068-2-6
<b>Tenue aux chocs mécaniques</b>	30 gn (durée = 18 ms) pour accélération d'une demi-onde sinusoïdale se conformer à CEI 60068-2-27 50 gn (durée = 11 ms) pour accélération d'une demi-onde sinusoïdale se conformer à CEI 60068-2-27

## Emballage

<b>Type d'emballage 1</b>	PCE
<b>Nb produits dans l'emballage 1</b>	1
<b>Hauteur de l'emballage 1</b>	4,400 cm
<b>Largeur de l'emballage 1</b>	5,300 cm
<b>Longueur de l'emballage 1</b>	8,800 cm
<b>Poids de l'emballage 1</b>	101,000 g
<b>Type d'emballage 2</b>	S03
<b>Nb produits dans l'emballage 2</b>	100
<b>Hauteur de l'emballage 2</b>	30,000 cm
<b>Largeur de l'emballage 2</b>	30,000 cm
<b>Longueur de l'emballage 2</b>	40,000 cm
<b>Poids de l'emballage 2</b>	10,564 kg

## Garantie contractuelle

<b>Garantie</b>	18 mois
-----------------	---------

## Environmental Data

Schneider Electric vise à atteindre le statut de Net Zero d'ici 2050 grâce à des partenariats avec la chaîne logistique, des matériaux à faible impact et une circularité via notre campagne en cours "Use Better, Use Longer, Use Again" pour prolonger la durée de vie des produits et leur recyclabilité.

[Environmental Data expliquées >](#)

### Empreinte environnementale

Empreinte carbone (kg CO2 eq.) 1

Profil environnemental [Profil environnemental du Produit](#)

## Use Better

### Matières et Substances

Emballage avec carton recyclé Non

Emballage sans plastique Non

[Directive UE RoHS](#) Conformité proactive (produit hors de la portée juridique de la directive européenne RoHS)

Numéro SCIP F28cb399-1b6a-409d-ac7b-4169e47b25c8

Règlementation REACH [Déclaration REACH](#)

## Use Again

### Réemballer et réutiliser

Profil Économie Circulaire [Informations de fin de vie](#)

Reprise No

Dimensions Drawings

## Dimensions

---

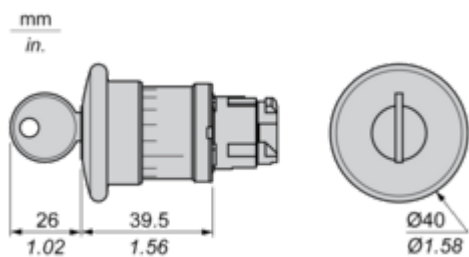

## Mounting and Clearance

### Panel Cut-out for Pushbuttons, Switches and Pilot Lights (Finished Holes, Ready for Installation)

Connection by Screw Clamp Terminals or Plug-in Connectors or on Printed Circuit Board	Connection by Faston Connectors
	
<p>(1) Diameter on finished panel or support</p> <p>(2) 40 mm min. / 1.57 in. min.</p> <p>(3) 30 mm min. / 1.18 in. min.</p> <p>(4) <math>\varnothing 22.5 \text{ mm} / 0.89 \text{ in.}</math> recommended (<math>\varnothing 22.3 \text{ mm} \begin{smallmatrix} +0.4 \\ 0 \end{smallmatrix} / 0.88 \text{ in.} \begin{smallmatrix} +0.016 \\ 0 \end{smallmatrix}</math>)</p> <p>(5) 45 mm min. / 1.78 in. min.</p> <p>(6) 32 mm min. / 1.26 in. min.</p>	

## Pushbuttons, Switches and Pilot Lights for Printed Circuit Board Connection

### Panel Cut-outs (Viewed from Installer's Side)



A: 30 mm min. / 1.18 in. min.

B: 40 mm min. / 1.57 in. min.

### Printed Circuit Board Cut-outs (Viewed from Electrical Block Side)

Dimensions in mm



A: 30 mm min.

B: 40 mm min.

Dimensions in in.



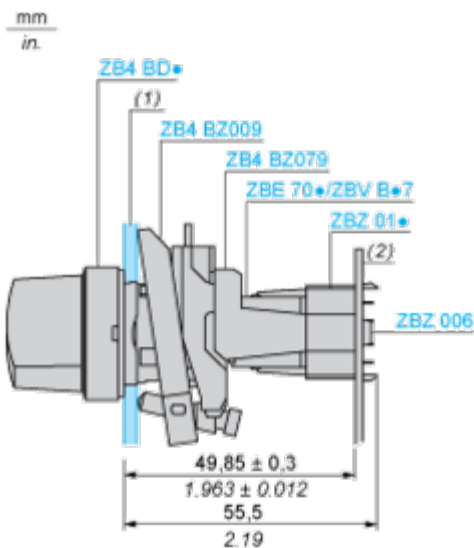

(1) Panel

(2) Printed circuit board

### Mounting of Adapter (Socket) ZBZ 01•

- 1 2 elongated holes for ZBZ 006 screw access
- 2 1 hole  $\varnothing 2.4 \text{ mm} \pm 0.05 / 0.09 \text{ in.} \pm 0.002$  for centring adapter ZBZ 01•
- 3  $8 \times \varnothing 1.2 \text{ mm} / 0.05 \text{ in.}$  holes
- 4 1 hole  $\varnothing 2.9 \text{ mm} \pm 0.05 / 0.11 \text{ in.} \pm 0.002$ , for aligning the printed circuit board (with cut-out marked a)
- 5 1 elongated hole for aligning the printed circuit board (with cut-out marked b)
- 6 4 holes  $\varnothing 2.4 \text{ mm} / 0.09 \text{ in.}$  for clipping in adapter ZBZ 01•

Dimensions An + 18.1 relate to the  $\varnothing 2.4 \text{ mm} \pm 0.05 / 0.09 \text{ in.} \pm 0.002$  holes for centring adapter ZBZ 01•.

Technical Description

**Electrical Composition Corresponding to Code C7**

---



Electrical Compositions Corresponding to Code C8

---

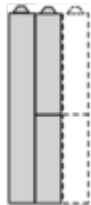

Electrical Compositions Corresponding to Code C10

---

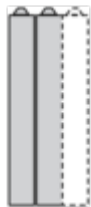

Electrical Composition Corresponding to Codes C9, C11, SF1 and SR1

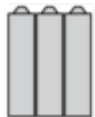

Electrical Composition Corresponding to Code C15

---

1 N/O



1 N/C

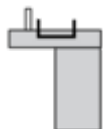

1 N/O + N/C or 1 N/O + N/O or 1 N/C + N/C

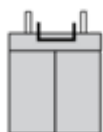

## Legend

---

Single contact



Double contact



Light block



Possible location



## Technical Illustration

### Dimensions

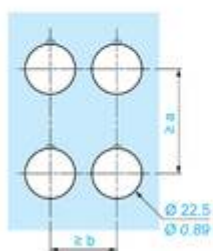
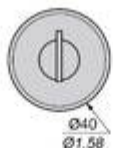
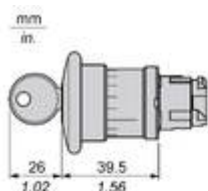

		a (mm)	a (in.)	b (mm)	b (in.)
		40	1.57	30	1.18
ZBE.....	ZBV.....				
		45	1.77	32	1.26
ZBE.....3	ZBV.....3				
		40	1.57	30	1.18
ZBE.....4	ZBV.....4				
		50	1.97	30	1.18
ZBE.....5	ZBV.....5				
		40	1.57	30	1.18
ZBE.....8	ZBV.....8				
		40	1.57	30	1.18
ZBRT•	ZBRV1				

Offer Marketing Illustration

Product benefits / Features

---

## Technical Benefits

### Harmony XB4 e-stop function

Fit to several customer functions needs: turn to release, push to release, key release

Guarantee of proper installation thanks to NC contact with monitoring function.



Fit for all machine sizes and environments:

- Small machines > 30 mm
- Standard machines > 40 mm
- Use of gloves > 60 mm

Designed as per international standards for high performance.

Offer Marketing Illustration

## Product benefits / Features

---

**Features**  
Harmony XB4 e-stop function

**Wide modular range** to suit machines and operator safety.

**Ergonomic design** for emergency actuation in several environments

Designed to fit in a standard 22mm cut-out or Harmony XAPK control station ensuring compatibility with pre-existing machinery.

Large set of accessories: circular legends, illuminated legend rings, protective bellows for harsh environments and protective guards.

The infographic features a central image of a Schneider Electric e-stop button with a red circular legend. The background is green, and the text is white and black.

Image of product / Alternate images

Alternative

---



