

Fiche technique du produit

Spécifications



Harmony tête de bouton poussoir + capuchon IP69K - Ø22 - bleu

ZB4BP6

Statut commercial: Commercialisé

Principales

Gamme de produit	Harmony XB4
Type de produit ou équipement	Tête de bouton-poussoir non lumineux
Nom de l'appareil	ZB4
Compatibilité produit	non compatible avec le porte-étiquette
Matériau de la collerette	Métal chromé
Diamètre de fixation	22,5 mm
Vente par quantité indivisible	1
Type de tête	Standard
Forme de la tête de l'unité de signalisation	Rond
Type d'unité de commande	rappel à ressort
Profil de l'unité de commande	Bleu dépassant, sans marquage
Info supplémentaire de l'unité de commande	Capuchon incolore
Couleur de la capsule	Bleu

Complémentaires

Largeur hors tout CAO	30 mm
Hauteur hors tout CAO	30 mm
Profondeur hors tout CAO	35 mm
Durée de vie mécanique	10000000 cycle
Code de composition électrique	C1 pour <9 contacts à l'aide desimple blocs dans montage avant C2 pour <9 contacts à l'aide desimple et double blocs dans montage avant C11 pour <3 contacts à l'aide desimple blocs dans montage avant C15 pour <1 contacts à l'aide desimple blocs dans montage avant
Présentation du produit	Élément de base

Environnement

Traitement de protection	TH
Température ambiante de stockage	-40...70 °C
Température ambiante de fonctionnement	-40...70 °C
Catégorie de surtension	Classe I conforming to CEI 60536
Degré de protection IP	IP66 se conformer à IEC 60529 IP67

Tenue à l'environnement NEMA	NEMA 13 NEMA 4X
Tenue aux chocs IK	IK06 conforme à CEI 50102
Normes	UL 508 CEI 60947-5-5 CEI 60947-5-4 IEC 60947-1 CEI 60947-5-1 JIS C8201-5-1 CSA C22.2 No 14 JIS C8201-1
Certifications du produit	BV CSA DNV LROS (Lloyds register of shipping) UL listed
Tenue aux vibrations	5 gn (f= 2...500 Hz) conforming to CEI 60068-2-6
Tenue aux chocs mécaniques	30 gn (durée = 18 ms) pour accélération d'une demi-onde sinusoïdale se conformer à CEI 60068-2-27 50 gn (durée = 11 ms) pour accélération d'une demi-onde sinusoïdale se conformer à CEI 60068-2-27

Emballage

Type d'emballage 1	PCE
Nb produits dans l'emballage 1	1
Hauteur de l'emballage 1	4,5 cm
Largeur de l'emballage 1	3,4 cm
Longueur de l'emballage 1	5,4 cm
Poids de l'emballage 1	32,0 g
Type d'emballage 2	S03
Nb produits dans l'emballage 2	300
Hauteur de l'emballage 2	30 cm
Largeur de l'emballage 2	30 cm
Longueur de l'emballage 2	40 cm
Poids de l'emballage 2	10,227 kg

Garantie contractuelle

Garantie	18 mois
-----------------	---------

Environmental Data

Schneider Electric vise à atteindre le statut de Net Zero d'ici 2050 grâce à des partenariats avec la chaîne logistique, des matériaux à faible impact et une circularité via notre campagne en cours "Use Better, Use Longer, Use Again" pour prolonger la durée de vie des produits et leur recyclabilité.

[Environmental Data expliquées >](#)

Empreinte environnementale

Empreinte carbone (kg CO2 eq.) 1

Profil environnemental [Profil environnemental du Produit](#)

Use Better

Matières et Substances

Emballage avec carton recyclé Oui

Emballage sans plastique Oui

[Directive UE RoHS](#) Conformité proactive (produit hors de la portée juridique de la directive européenne RoHS)

Règlementation REACH [Déclaration REACH](#)

Use Again

Réemballer et réuser

Profil Économie Circulaire [Informations de fin de vie](#)

Reprise No

Dimensions Drawings

Dimensions

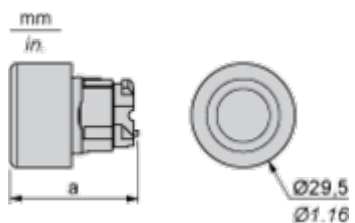

	a in mm	a in in.
ZB4BP••	36.5	1.44
ZB4BP•S	33	1.30
ZB4BP•83	32	1.26
ZB4BP•	35	1.38

Mounting and Clearance

Panel Cut-out for Pushbuttons, Switches and Pilot Lights (Finished Holes, Ready for Installation)

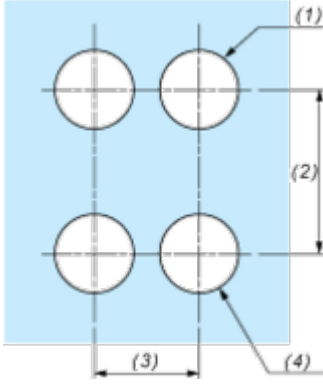
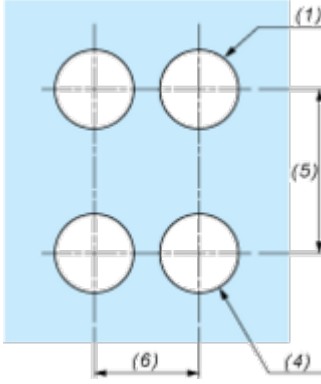
Connection by Screw Clamp Terminals or Plug-in Connectors or on Printed Circuit Board	Connection by Faston Connectors
	
<p>(1) Diameter on finished panel or support</p> <p>(2) 40 mm min. / 1.57 in. min.</p> <p>(3) 30 mm min. / 1.18 in. min.</p> <p>(4) $\varnothing 22.5 \text{ mm} / 0.89 \text{ in.}$ recommended ($\varnothing 22.3 \text{ mm} \begin{smallmatrix} +0.4 \\ 0 \end{smallmatrix} / 0.88 \text{ in.} \begin{smallmatrix} +0.016 \\ 0 \end{smallmatrix}$)</p> <p>(5) 45 mm min. / 1.78 in. min.</p> <p>(6) 32 mm min. / 1.26 in. min.</p>	

Pushbuttons, Switches and Pilot Lights for Printed Circuit Board Connection

Panel Cut-outs (Viewed from Installer's Side)



A: 30 mm min. / 1.18 in. min.

B: 40 mm min. / 1.57 in. min.

Printed Circuit Board Cut-outs (Viewed from Electrical Block Side)

Dimensions in mm



A: 30 mm min.

B: 40 mm min.

Dimensions in in.



A: 1.18 in. min.
 B: 1.57 in. min.

General Tolerances of the Panel and Printed Circuit Board

The cumulative tolerance must not exceed 0.3 mm / 0.012 in: T1 + T2 = 0.3 mm max.

Installation Precautions

- Minimum thickness of circuit board: 1.6 mm / 0.06 in.
- Cut-out diameter: 22.4 mm ± 0.1 / 0.88 in. ± 0.004
- Orientation of body/fixing collar ZB4 BZ009: ± 2° 30' (excluding cut-outs marked a and b).
- Tightening torque of screws ZBZ 006: 0.6 N.m (5.3 lbf.in) max.
- Allow for one ZB4 BZ079 fixing collar/pillar and its fixing screws:
 - every 90 mm / 3.54 in. horizontally (X), and 120 mm / 4.72 in. vertically (Y).
 - with each selector switch head (ZB4 BD*, ZB4 BJ*, ZB4 BG*).

The fixing centers marked a and b are diagonally opposed and must align with those marked 4 and 5.

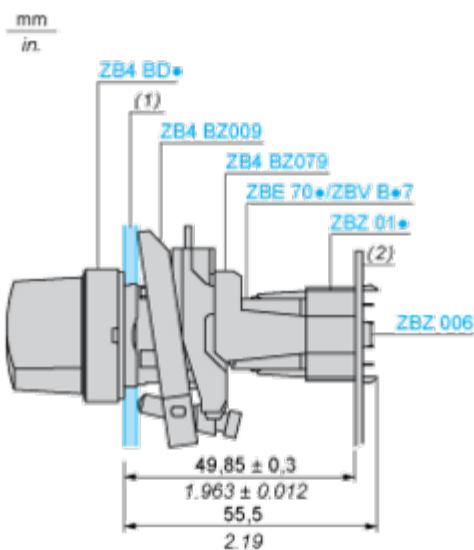

(1) Panel

(2) Printed circuit board

Mounting of Adapter (Socket) ZBZ 01•

- 1 2 elongated holes for ZBZ 006 screw access
- 2 1 hole $\varnothing 2.4 \text{ mm} \pm 0.05 / 0.09 \text{ in.} \pm 0.002$ for centring adapter ZBZ 01•
- 3 $8 \times \varnothing 1.2 \text{ mm} / 0.05 \text{ in.}$ holes
- 4 1 hole $\varnothing 2.9 \text{ mm} \pm 0.05 / 0.11 \text{ in.} \pm 0.002$, for aligning the printed circuit board (with cut-out marked a)
- 5 1 elongated hole for aligning the printed circuit board (with cut-out marked b)
- 6 4 holes $\varnothing 2.4 \text{ mm} / 0.09 \text{ in.}$ for clipping in adapter ZBZ 01•

Dimensions An + 18.1 relate to the $\varnothing 2.4 \text{ mm} \pm 0.05 / 0.09 \text{ in.} \pm 0.002$ holes for centring adapter ZBZ 01•.

Technical Description

Electrical Composition Corresponding to Code C1



Electrical Composition Corresponding to Code C2



Electrical Composition Corresponding to Codes C9, C11, SF1 and SR1



Electrical Composition Corresponding to Code C15

1 N/O



1 N/C

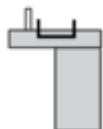

1 N/O + N/C or 1 N/O + N/O or 1 N/C + N/C

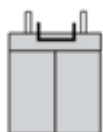

Legend

Single contact



Double contact



Light block



Possible location



Technical Illustration

Dimensions

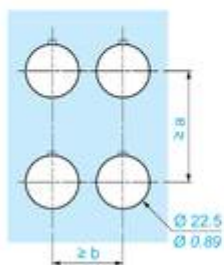
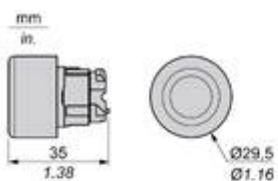

		a (mm)	a (in.)	b (mm)	b (in.)
		40	1.57	30	1.18
ZBE.....	ZBV.....				
		45	1.77	32	1.26
ZBE.....3	ZBV.....3				
		40	1.57	30	1.18
ZBE.....4	ZBV.....4				
		50	1.97	30	1.18
ZBE.....5	ZBV.....5				
		40	1.57	30	1.18
ZBE.....9	ZBV.....9				
		40	1.57	30	1.18
ZBRT●	ZBRV1				

Offer Marketing Illustration

Product benefits / Features

Technical Benefits

Harmony XB4

Conformity with IEC, UL, CSA, CCC EAC, and JIS standards, as well as CE marking and marine approvals

Up to IP66, 67, 69, 69K, and type 4X protection ratings

High vibration resistance with shake-proof terminal screws

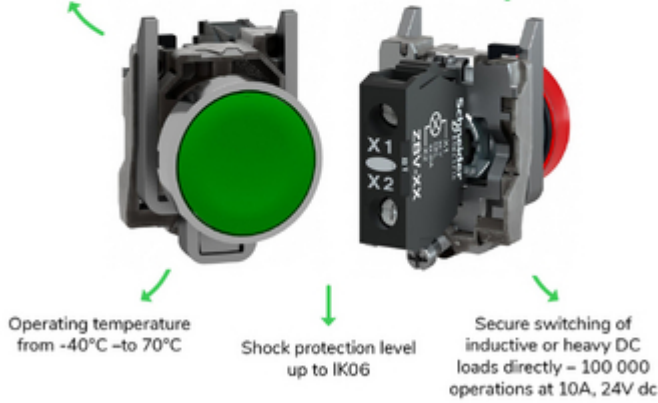

Offer Marketing Illustration

Product benefits / Features

Features Harmony XB4

- Quick and easy assembly and disassembly
- Excellent mechanical connection with operator head
- Various types of connection: screw clamp, connector, Faston connector, spring terminal, or printed circuit board
- Large set of accessories to customize your panels
- Robustness to withstand harsh environments

Image of product / Alternate images

Alternative



