



	<b>KIT HIDRO</b>			<b>Code / Réf</b>	
				51044	51190
				51045	51191





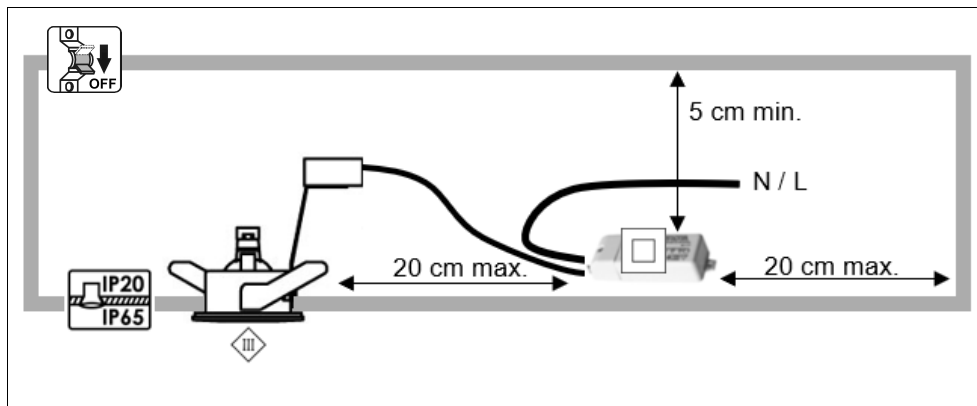

220-240V-50/60Hz	GU5,3	6,3 W	IK02							
------------------	-------	-------	------	---	---	---	---	---	---	---

Code / Réf	<input type="checkbox"/> / <input type="checkbox"/>	CCT
51044	<input type="checkbox"/>	3000K
51045	<input type="checkbox"/>	4000K
51190	<input type="checkbox"/>	3000K
51191	<input type="checkbox"/>	4000K



<b>FR</b>	 Ne jetez pas vos déchets électriques avec les déchets ménagers. Confiez votre appareil à votre centre de recyclage pour son traitement approprié.	 Suivez la fiche d'instructions pour garantir un fonctionnement fiable et sécurisé. À conserver pour consultation ultérieure. Les produits doivent être installés par un électricien qualifié conformément aux normes internationales de câblage.
<b>EN</b>	Waste electrical products must not be disposed of with household waste. This tool should be taken to your recycling center for safe treatment.	Follow Instruction Sheet to ensure safe and reliable operation. Retain for future reference. Products should be installed by a qualified Electrician in accordance with International Wiring Regulations.
<b>DE</b>	Dieses Gerät darf nicht mit dem Hausmüll/Restmüll entsorgt werden. Das Altgerät nur in einer öffentlichen Sammelstelle abgeben.	Die Gebrauchsanweisung befolgen, damit der sichere und zuverlässige Betrieb gewährleistet ist. Zum späteren Nachschlagen aufheben. Die Produkte müssen von einem qualifizierten Elektriker in Übereinstimmung mit den relevanten Vorschriften installiert werden.
<b>IT</b>	I rifiuti elettrici non devono essere smaltiti con i rifiuti domestici. Questo strumento deve essere portato al centro di riciclaggio per un trattamento sicuro.	Seguire il foglio delle istruzioni per garantire il funzionamento sicuro e affidabile. Conservare per riferimento futuro. I prodotti devono essere installati da un elettricista qualificato conformemente alle normative internazionali sui cablaggi.
<b>ES</b>	Los productos eléctricos de desecho no deben ser eliminados con residuos domésticos. Esta herramienta debe ser llevada a su centro de reciclaje para un tratamiento seguro.	Siiga la hoja de instrucciones para garantizar la seguridad y un funcionamiento fiable. Consérvela para utilizarla como material de referencia en el futuro. Los productos los debe instalar un técnico electricista cualificado en virtud de las normativas internacionales en materia de cableado.
<b>FR</b>	Ce produit contient une source lumineuse de classe d'efficacité énergétique	<b>F</b> 
<b>EN</b>	This product contains a light source of energy efficiency class	
<b>DE</b>	Dieses Produkt enthält eine Lichtquelle der Energieeffizienzklasse	
<b>IT</b>	Questo prodotto contiene una sorgente luminosa di classe di efficienza energetica	
<b>ES</b>	Este producto contiene una fuente luminosa de la clase de eficiencia energética	



	<b>KIT HIDRO</b>			<b>Code / Réf</b>	
				51044	51190
				51045	51191

220-240V-50/60Hz	GU5,3	6,3 W	IK02							
------------------	-------	-------	------	---	---	---	---	---	---	---

Code / Réf	<input type="checkbox"/> / <input type="checkbox"/>	CCT
51044	<input type="checkbox"/>	3000K
51045	<input type="checkbox"/>	4000K
51190	<input type="checkbox"/>	3000K
51191	<input type="checkbox"/>	4000K

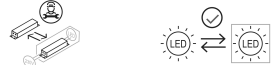
<b>FR</b>	 Ne jetez pas vos déchets électriques avec les déchets ménagers. Confiez votre appareil à votre centre de recyclage pour son traitement approprié.	 Suivez la fiche d'instructions pour garantir un fonctionnement fiable et sécurisé. À conserver pour consultation ultérieure. Les produits doivent être installés par un électricien qualifié conformément aux normes internationales de câblage.
<b>EN</b>	Waste electrical products must not be disposed of with household waste. This tool should be taken to your recycling center for safe treatment.	Follow Instruction Sheet to ensure safe and reliable operation. Retain for future reference. Products should be installed by a qualified Electrician in accordance with International Wiring Regulations.
<b>DE</b>	Dieses Gerät darf nicht mit dem Hausmüll/Restmüll entsorgt werden. Das Altgerät nur in einer öffentlichen Sammelstelle abgeben.	Die Gebrauchsanweisung befolgen, damit der sichere und zuverlässige Betrieb gewährleistet ist. Zum späteren Nachschlagen aufheben. Die Produkte müssen von einem qualifizierten Elektriker in Übereinstimmung mit den relevanten Vorschriften installiert werden.
<b>IT</b>	I rifiuti elettrici non devono essere smaltiti con i rifiuti domestici. Questo strumento deve essere portato al centro di riciclaggio per un trattamento sicuro.	Seguire il foglio delle istruzioni per garantire il funzionamento sicuro e affidabile. Conservare per riferimento futuro. I prodotti devono essere installati da un elettricista qualificato conformemente alle normative internazionali sui cablaggi.
<b>ES</b>	Los productos eléctricos de desecho no deben ser eliminados con residuos domésticos. Esta herramienta debe ser llevada a su centro de reciclaje para un tratamiento seguro.	Siiga la hoja de instrucciones para garantizar la seguridad y un funcionamiento fiable. Consérvela para utilizarla como material de referencia en el futuro. Los productos los debe instalar un técnico electricista cualificado en virtud de las normativas internacionales en materia de cableado.
<b>FR</b>	Ce produit contient une source lumineuse de classe d'efficacité énergétique	<b>F</b> 
<b>EN</b>	This product contains a light source of energy efficiency class	
<b>DE</b>	Dieses Produkt enthält eine Lichtquelle der Energieeffizienzklasse	
<b>IT</b>	Questo prodotto contiene una sorgente luminosa di classe di efficienza energetica	
<b>ES</b>	Este producto contiene una fuente luminosa de la clase de eficiencia energética	

