

**KBC10DCC211**  
**KBC10DCC21Z**  
**KBC10DCB20**

KBC10DCC211

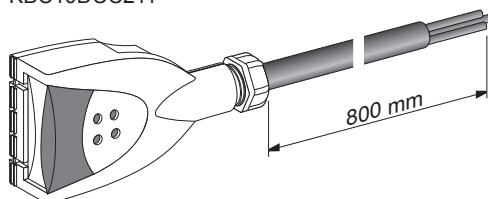

KBC10DCC21Z

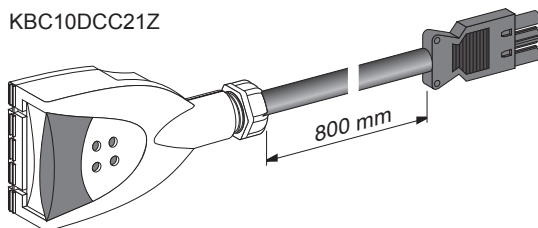

KBC10DCB20

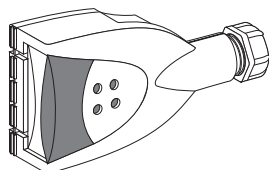

|   |   |
|---|---|
| <p><b>PLEASE NOTE</b><br/>Electrical equipment should be installed, operated, serviced, and maintained only by qualified personnel. No responsibility is assumed by Schneider Electric for any consequences arising out of the use of this material.</p>  | <p><b>REMARQUE IMPORTANTE</b><br/>L'installation, l'utilisation, la réparation et la maintenance des équipements électriques doivent être assurées par du personnel qualifié uniquement. Schneider Electric décline toute responsabilité quant aux conséquences de l'utilisation de cet appareil.</p>   |
| <p><b>TENGA EN CUENTA</b><br/>La instalación, manejo, puesta en servicio y mantenimiento de equipos eléctricos deberán ser realizados sólo por personal cualificado. Schneider Electric no se hace responsable de ninguna de las consecuencias del uso de este material.</p>  | <p><b>BITTE BEACHTEN</b><br/>Elektrische Geräte dürfen nur von Fachpersonal installiert, betrieben, bedient und gewartet werden. Schneider Electric haftet nicht für Schäden, die durch die Verwendung dieses Materials entstehen.</p>  |
| <p><b>NOTA</b><br/>Manutenzione, riparazione, installazione e uso delle apparecchiature elettriche si devono affidare solo a personale qualificato. Schneider Electric non si assume alcuna responsabilità per qualsiasi conseguenza derivante dall'uso di questi prodotti.</p>   | <p><b>NOTA</b><br/>A instalação, utilização e manutenção do equipamento eléctrico devem ser efectuadas exclusivamente por pessoal qualificado. A Schneider Electric não assume qualquer responsabilidade pelas consequências resultantes da utilização deste material.</p>  |
| <p>请注意<br/>电气设备的安装、操作、维修和维护工作仅限于合格人员执行。<br/>Schneider Electric不承担由于使用本资料所引起的任何后果。</p>   | <p><b>ОБРАТИТЕ ВНИМАНИЕ</b><br/>Электрическое оборудование должно обслуживаться квалифицированным персоналом. Компания Schneider Electric не несет ответственности за последствия, связанные с использованием данной документации. Данная документация не предназначена для использования в качестве руководства людьми, не прошедшими какого-либо обучения.</p>          |
| <p><b>Schneider Electric Industries SAS</b><br/>35, rue Joseph Monier<br/>CS 30323<br/>F - 92506 Rueil Malmaison Cedex</p>  | <p><b>Уполномоченный поставщик в РФ:</b><br/><b>АО «Шнейдер Электрик»</b><br/>Адрес: 127018, г. Москва, ул. Двинцев, д. 12, корп. 1, тел. +7 (495)777 99 88, факс: +7 (495)777 99 94, 8-800-200-6446<br/><a href="http://www.schneider-electric.ru">www.schneider-electric.ru</a></p>  |
| <p>The product's manufacture date is coded PP-YYYY-Wwww, where:<br/>● PP: plant code<br/>● YYYY: year of manufacture<br/>● Wwww: week of manufacture<br/>Example: 7Q-2014-W19 means the product manufactured at plant 7Q on week 19 2014.</p>   | <p>La date de fabrication du produit est codée sous la forme PP-YYYY-Wwww, où :<br/>● PP: code de l'usine<br/>● YYYY: année de fabrication<br/>● Wwww: semaine de fabrication<br/>Exemple: 7Q-2014-W19 signifie que le produit a été fabriqué à l'usine 7Q la semaine 19 de 2014.</p>   |
| <p>La fecha fabricación del producto está codificada como PP-YYYY-Wwww, donde:<br/>● PP: código de planta<br/>● YYYY: año de fabricación<br/>● Wwww: semana de fabricación<br/>Por ejemplo: 7Q-2014-W19 significa que el producto ha sido fabricado en la planta 7Q, la semana 19 del año 2014.</p>                             | <p>Das Herstellungsdatum des Produkts weist folgendes Format auf: PP-YYYY-Wwww. Hierbei gilt Folgendes:<br/>● PP: Code der Produktionsstätte<br/>● YYYY: Herstellungsjahr<br/>● Wwww: Herstellungswoche<br/>Beispiel: 7Q-2014-W19 kennzeichnet ein Produkt, das in der Produktionsanlage 7Q in der Woche 19 des Jahres 2014 hergestellt wurde.</p>                        |
| <p>La data di costruzione del prodotto è codificata come segue PP-YYYY-Wwww, dove:<br/>● PP: Codice stabilimento<br/>● YYYY: Anno di costruzione<br/>● Wwww: settimana di fabbricazione<br/>Esempio: Il codice 7Q-2014-W19 indica che il prodotto è stato fabbricato presso lo stabilimento 7Q nella settimana 19 del 2014.</p> | <p>A data de fabrico do produto está codificada como PP-YYYY-Wwww, sendo que:<br/>● PP: Código de fábrica<br/>● YYYY: Ano do fabrico<br/>● Wwww: semana de fabrico<br/>Exemplo: 7Q-2014-W19 significa que o produto foi criado na fábrica 7Q na semana 19 de 2014.</p>  |
| <p>产品制造日期采用如下代码 PP-YYYY-Wwww, 其中:<br/>● PP: 工厂代码<br/>● YYYY: 制造年份<br/>● Wwww: 第几周制造<br/>示例: 7Q-2014-W19 表示该产品于 2014 年第 19 周在工厂 7Q 制造。</p>   | <p>Дата производства продукта указана в виде кода PP-YYYY-Wwww, где:<br/>● PP: код завода;<br/>● YYYY: год производства;<br/>● Wwww: неделя производства<br/>Пример: 7Q-2014-W19 означает, что продукт произведен на заводе 7Q на 19-й неделе 2014 года.</p>  |

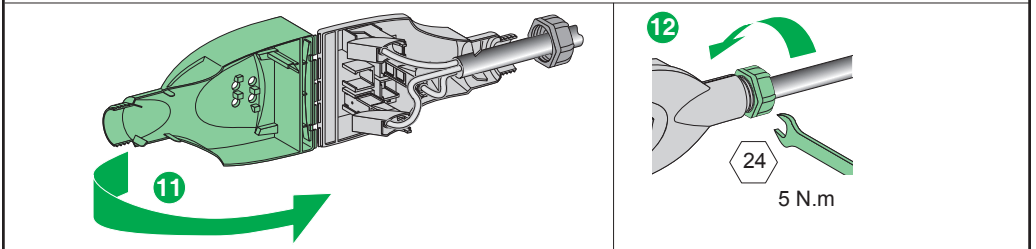
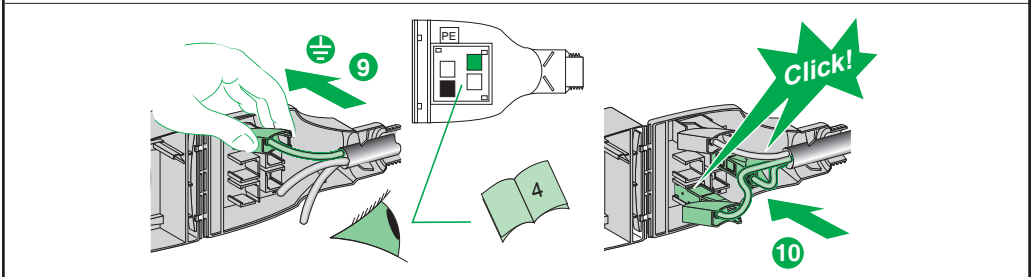
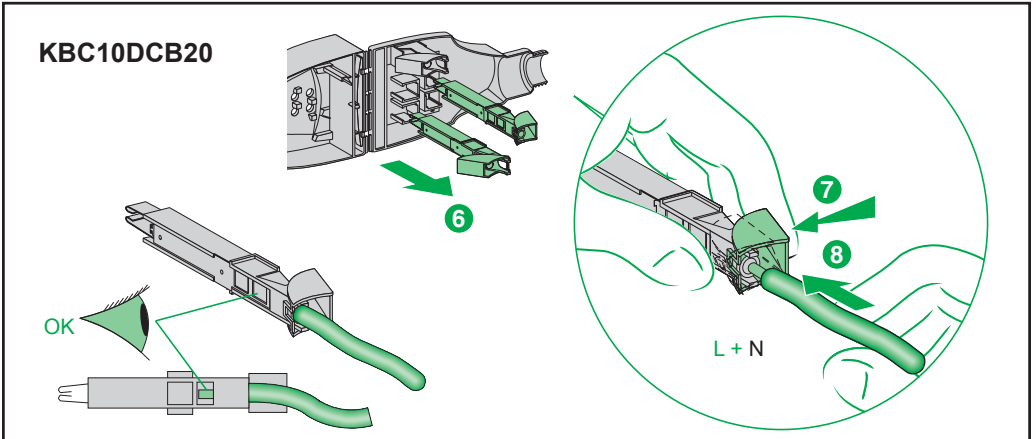
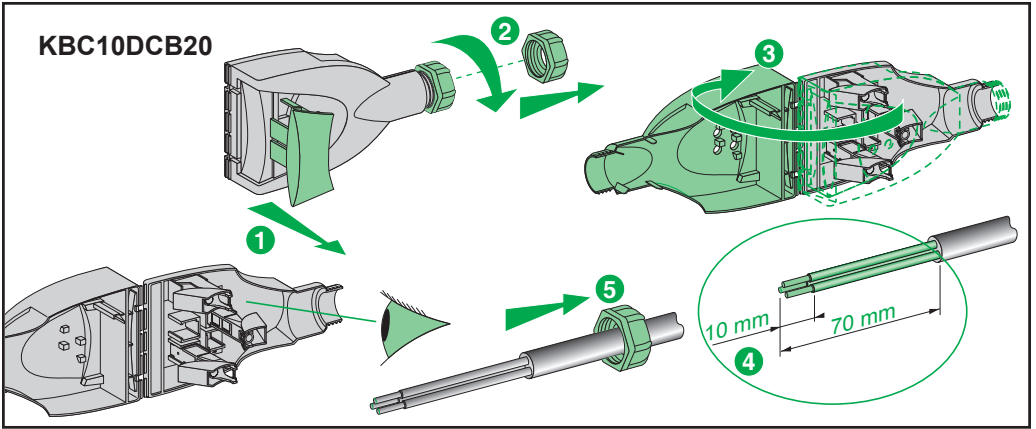

**L + N + PE**

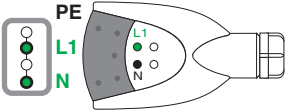
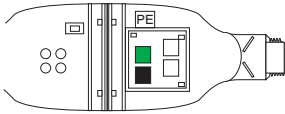

**L1 + N + PE**

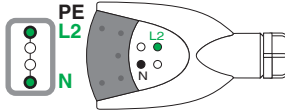
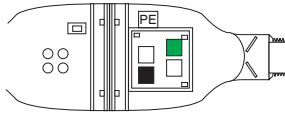

**L2 + N + PE**

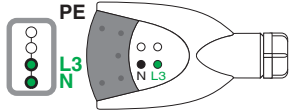
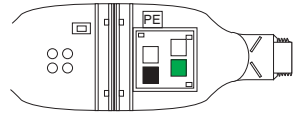

**L3 + N + PE**

**L + L + PE**

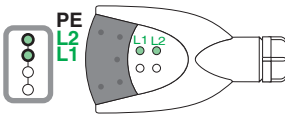
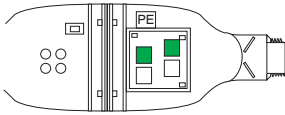

**L1 + L2 + PE**

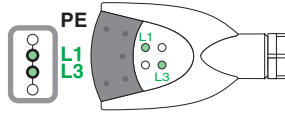
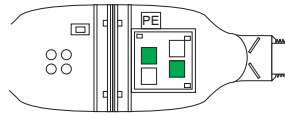

**L1 + L3 + PE**

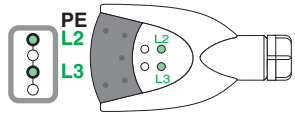
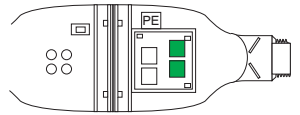

**L2 + L3 + PE**

**L + N + PE**

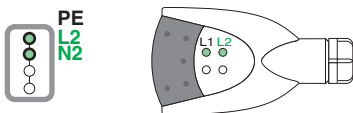
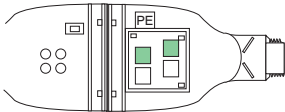

**L2 + N2 (L1 = N2) + PE**

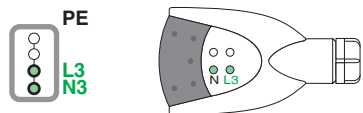
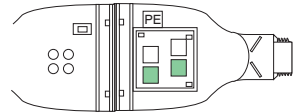

**L3 + N3 (N = N3) + PE**

# KBA-KBB

