

# Fiche technique du produit

Spécifications



## Harmony tête de arrêt d'urgence Ø 30 - tourner pour déverrouiller - Ø22 - rouge

ZB5AS834

Statut commercial: Commercialisé

### Principales

Gamme de produit	Harmony XB5
Type de produit ou équipement	Tête de bouton-poussoir d'arrêt d'urgence
Destination du produit	Bouton-poussoir d'arrêt d'urgence
Nom de l'appareil	ZB5
Matériau de la collerette	Plastique gris foncé
Type de tête	Standard
Diamètre de fixation	22 mm
Vente par quantité indivisible	1
Forme de la tête de l'unité de signalisation	Rond
Type d'unité de commande	déclenchement et accrochage mécanique
Remise à zéro	Tourner pour déverrouiller
Profil de l'unité de commande	Rouge coup de poing Ø 30 mm, sans marquage
Présentation du produit	Élément de base

### Complémentaires

Largeur hors tout CAO	30 mm
Hauteur hors tout CAO	30 mm
Profondeur hors tout CAO	57 mm
Poids du produit	0,042 kg
Durée de vie mécanique	300000 cycle
Boîte associée	XALD 1...5 découpes XALK 1...5 découpes
Code de composition électrique	C7 pour <4 contacts à l'aide desimple blocs dans montage avant C8 pour <4 contacts à l'aide desimple et double blocs dans montage avant C11 pour <3 contacts à l'aide desimple blocs dans montage avant C15 pour <1 contacts à l'aide desimple blocs dans montage avant SF1 pour <3 contacts à l'aide desimple blocs dans montage avant SR1 pour <3 contacts à l'aide desimple blocs dans montage arrière C10 pour <4 contacts à l'aide desimple et double blocs dans montage avant
Code de compatibilité	ZB5

### Environnement

Traitement de protection	TH
Température ambiante de stockage	-40...70 °C
Température ambiante de fonctionnement	-40...70 °C

<b>Catégorie de surtension</b>	Classe II conforming to CEI 60536
<b>Degré de protection IP</b>	IP66 se conformer à IEC 60529 IP67 IP69 IP69K
<b>Tenue à l'environnement NEMA</b>	NEMA 13 NEMA 4X
<b>Tenue au nettoyage haute pression</b>	7000000 Pa à 55 °C, distance : 0,1 m
<b>Tenue aux chocs IK</b>	IK03 conforme à CEI 50102
<b>Normes</b>	CEI 60364-5-53 CEI 60947-5-5 GB 14048.5 JIS C8201-5-1 CEI 60947-5-4 IEC 60947-1 ISO 13850 UL 508 CEI 60204-1 CEI 60947-5-1 CSA C22.2 No 14 JIS C8201-1
<b>Certifications du produit</b>	CSA DNV BV LROS (Lloyds register of shipping) UL listed
<b>Tenue aux vibrations</b>	5 gn (f= 2...500 Hz) conforming to CEI 60068-2-6
<b>Tenue aux chocs mécaniques</b>	30 gn (durée = 18 ms) pour accélération d'une demi-onde sinusoïdale se conformer à CEI 60068-2-27 50 gn (durée = 11 ms) pour accélération d'une demi-onde sinusoïdale se conformer à CEI 60068-2-27

## Emballage

<b>Type d'emballage 1</b>	PCE
<b>Nb produits dans l'emballage 1</b>	1
<b>Hauteur de l'emballage 1</b>	4,600 cm
<b>Largeur de l'emballage 1</b>	5,500 cm
<b>Longueur de l'emballage 1</b>	8,900 cm
<b>Poids de l'emballage 1</b>	39,000 g
<b>Type d'emballage 2</b>	S03
<b>Nb produits dans l'emballage 2</b>	100
<b>Hauteur de l'emballage 2</b>	30,000 cm
<b>Largeur de l'emballage 2</b>	30,000 cm
<b>Longueur de l'emballage 2</b>	40,000 cm
<b>Poids de l'emballage 2</b>	4,330 kg
<b>Type d'emballage 3</b>	P06
<b>Nb produits dans l'emballage 3</b>	800
<b>Hauteur de l'emballage 3</b>	75,000 cm
<b>Largeur de l'emballage 3</b>	60,000 cm
<b>Longueur de l'emballage 3</b>	80,000 cm
<b>Poids de l'emballage 3</b>	45,404 kg

# Garantie contractuelle

---

Garantie

18 mois

## Environmental Data

Schneider Electric vise à atteindre le statut de Net Zero d'ici 2050 grâce à des partenariats avec la chaîne logistique, des matériaux à faible impact et une circularité via notre campagne en cours "Use Better, Use Longer, Use Again" pour prolonger la durée de vie des produits et leur recyclabilité.

[Environmental Data expliquées >](#)

### Empreinte environnementale

Empreinte carbone (kg CO2 eq.)	1
--------------------------------	---

Profil environnemental	<a href="#">Profil environnemental du Produit</a>
------------------------	---

### Use Better

#### Matières et Substances

Emballage avec carton recyclé	Non
-------------------------------	-----

Emballage sans plastique	Non
--------------------------	-----

<a href="#">Directive UE RoHS</a>	Conformité proactive (produit hors de la portée juridique de la directive européenne RoHS)
-----------------------------------	--

Règlementation REACH	<a href="#">Déclaration REACH</a>
----------------------	-----------------------------------

### Use Again

#### Réemballer et réuser

Profil Économie Circulaire	<a href="#">Informations de fin de vie</a>
----------------------------	--

Reprise	No
---------	----

Dimensions Drawings

## Dimensions

---

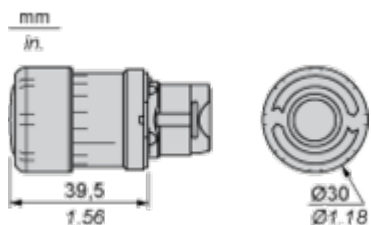

## Mounting and Clearance

### Panel Cut-out for Pushbuttons, Switches and Pilot Lights (Finished Holes, Ready for Installation)

#### Connection by Screw Clamp Terminals or Plug-in Connectors or on Printed Circuit Board

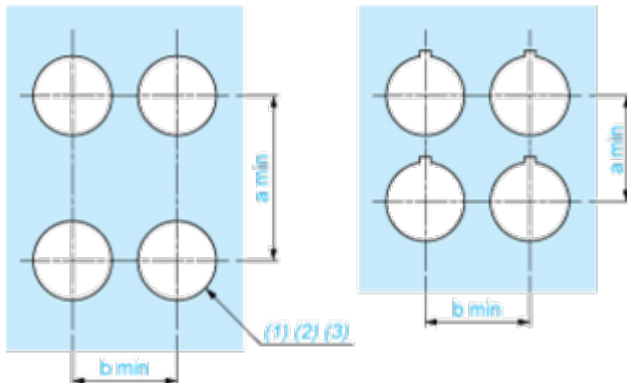

- (1) Diameter on finished panel or support
- (2) For selector switches and Emergency stop buttons, use of an anti-rotation plate type ZB5AZ902 is recommended.
- (3)  $\varnothing 22.5$  mm recommended ( $\varnothing 22.3_0^{+0.4}$ ) /  $\varnothing 0.89$  in. recommended ( $\varnothing 0.88_0^{+0.016}$ )

Connections	a in mm	a in in.	b in mm	b in in.
By screw clamp terminals or plug-in connector	40	1.57	30	1.18
By Faston connectors	45	1.77	32	1.26
On printed circuit board	30	1.18	30	1.18

#### Detail of Lug Recess



- (1) Diameter on finished panel or support
- (2) For selector switches and Emergency stop buttons, use of an anti-rotation plate type ZB5AZ902 is recommended.
- (3)  $\varnothing 22.5$  mm recommended ( $\varnothing 22.3_0^{+0.4}$ ) /  $\varnothing 0.89$  in. recommended ( $\varnothing 0.88_0^{+0.016}$ )

Pushbuttons, Switches and Pilot Lights for Printed Circuit Board Connection

Panel Cut-outs (Viewed from Installer's Side)

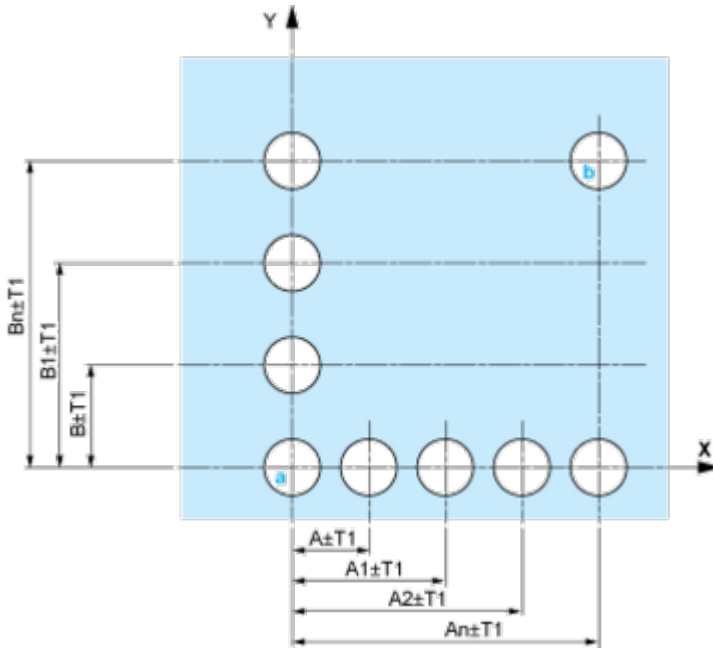

A: 30 mm min. / 1.18 in. min.  
 B: 40 mm min. / 1.57 in. min.

Printed Circuit Board Cut-outs (Viewed from Electrical Block Side)

Dimensions in mm

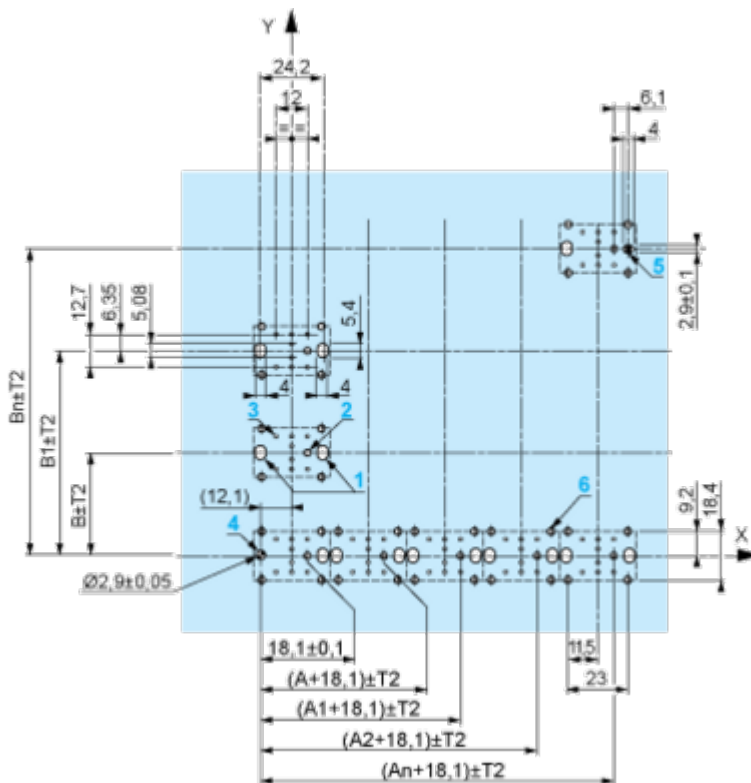

A: 30 mm min.  
 B: 40 mm min.  
 Dimensions in in.

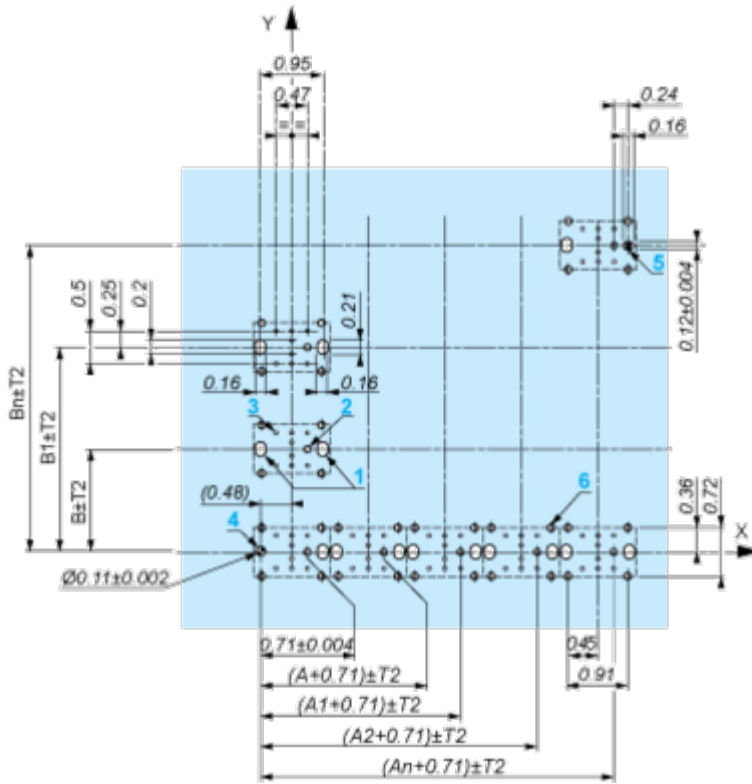

A: 1.18 in. min.  
 B: 1.57 in. min.

**General Tolerances of the Panel and Printed Circuit Board**

The cumulative tolerance must not exceed 0.3 mm / 0.012 in.: T1 + T2 = 0.3 mm max.

**Installation Precautions**

- Minimum thickness of circuit board: 1.6 mm / 0.06 in.
- Cut-out diameter: 22.4 mm ± 0.1 / 0.88 in. ± 0.004
- Orientation of body/fixing collar ZB5AZ009: ± 2° 30' (excluding cut-outs marked a and b).
- Tightening torque of screws ZBZ006: 0.6 N.m (5.3 lbf.in) max.
- Allow for one ZB5AZ079 fixing collar/pillar and its fixing screws:
  - every 90 mm / 3.54 in. horizontally (X), and 120 mm / 4.72 in. vertically (Y).
  - with each selector switch head (ZB5AD\*, ZB5AJ\*, ZB5AG\*).

The fixing centers marked a and b are diagonally opposed and must align with those marked 4 and 5.

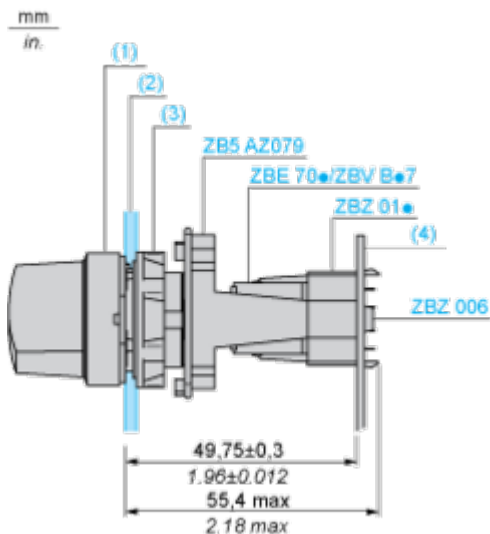

- (1) Head ZB5AD•
- (2) Panel
- (2) Nut
- (4) Printed circuit board

## Mounting of Adapter (Socket) ZBZ01•

- 1 2 elongated holes for ZBZ006 screw access
- 2 1 hole  $\varnothing$  2.4 mm  $\pm$  0.05 / 0.09 in.  $\pm$  0.002 for centring adapter ZBZ01•
- 3 8  $\times$   $\varnothing$  1.2 mm / 0.05 in. holes
- 4 1 hole  $\varnothing$  2.9 mm  $\pm$  0.05 / 0.11 in.  $\pm$  0.002, for aligning the printed circuit board (with cut-out marked **a**)
- 5 1 elongated hole for aligning the printed circuit board (with cut-out marked **b**)
- 6 4 holes  $\varnothing$  2.4 mm / 0.09 in. for clipping in adapter ZBZ01•

Dimensions An + 18.1 relate to the  $\varnothing$  2.4 mm  $\pm$  0.05 / 0.09 in.  $\pm$  0.002 holes for centring adapter ZBZ01•.

Technical Description

**Electrical Composition Corresponding to Code C7**

---



Electrical Compositions Corresponding to Code C8

---

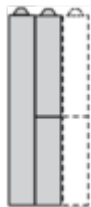

Electrical Compositions Corresponding to Code C10

---

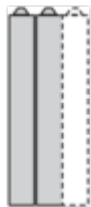

Electrical Composition Corresponding to Codes C9, C11, SF1 and SR1

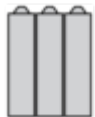

Electrical Composition Corresponding to Code C15

---

1 N/O

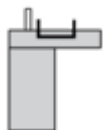

1 N/C

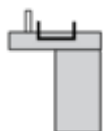

1 N/O + N/C or 1 N/O + N/O or 1 N/C + N/C

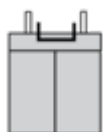

## Legend

---

Single contact



Double contact



Light block



Possible location



## Technical Illustration

### Dimensions

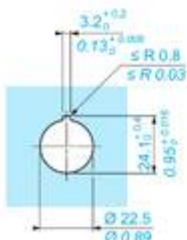
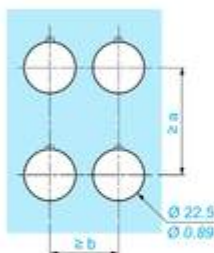
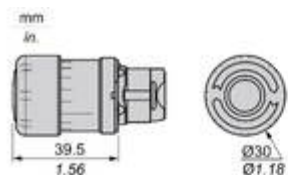

		a (mm)	a (in.)	b (mm)	b (in.)
ZBE.....	ZBV.....	40	1.57	30	1.18
ZBE.....3	ZBV.....3	45	1.77	32	1.26
ZBE.....4	ZBV.....4	40	1.57	30	1.18
ZBE.....5	ZBV.....5	50	1.97	30	1.18
ZBE.....9	ZBV.....9	40	1.57	30	1.18
ZBRT..	ZBRV1	40	1.57	30	1.18



Offer Marketing Illustration

## Product benefits / Features

---

### Caractéristiques

Harmony XB5  
avec fonction e-stop



**Large gamme modulaire pour s'adapter aux machines et à la sécurité des opérateurs**

**Design ergonomique pour l'actionnement d'urgence dans divers environnements**

**Conçu pour s'adapter à une découpe standard de 22 mm et aux machines préexistantes**

**Large gamme d'accessoires : étiquettes circulaires, anneaux lumineux, éléments de protection pour les environnements difficiles**

Modèles lumineux pour améliorer l'efficacité de l'opérateur en réduisant les temps d'arrêt de production

Offer Marketing Illustration

Product benefits / Features

---

## Avantages techniques

Harmony XB5 avec fonction e-stop

S'adapte à plusieurs besoins:  
tourner pour débloquer, tirer pour débloquer, débloquer par clé

Garantie d'une installation sécurisée grâce au contact NF avec fonction de surveillance



Conçus selon les normes internationales pour de hautes performances

Trois tailles de têtes : 30mm, 40mm, 60mm

Offer Marketing Illustration

Product benefits / Features

---

## Technical Benefits

Harmony XB5 e-stop function

Fit to several customer functions needs: turn to release, push to release, key release

Guarantee of proper installation thanks to NC contact with monitoring function.



Designed as per international standards for high performance.

Fit for all machine sizes and environments:

- Small machines > 30 mm
- Standard machines > 40 mm
- Use of gloves > 60 mm

Offer Marketing Illustration

## Product benefits / Features

---

### Features

#### Harmony XB5 e-stop function



-  Wide modular range to suit machines and operator safety.
-  Ergonomic design for emergency actuation in several environments
-  Designed to fit in a standard 22mm cut-out or Harmony XALK control station ensuring compatibility with pre-existing machinery
-  Illuminated types to improve operator efficiency by reducing production downtime.
-  Large set of accessories: circular legends, illuminated legend rings, protective bellows for harsh environments and protective guards.

Image of product / Alternate images

Alternative

---





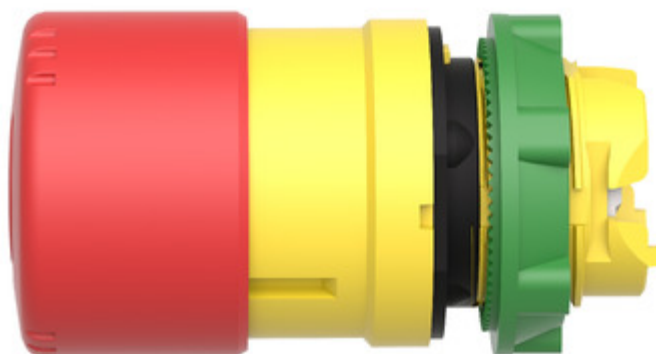
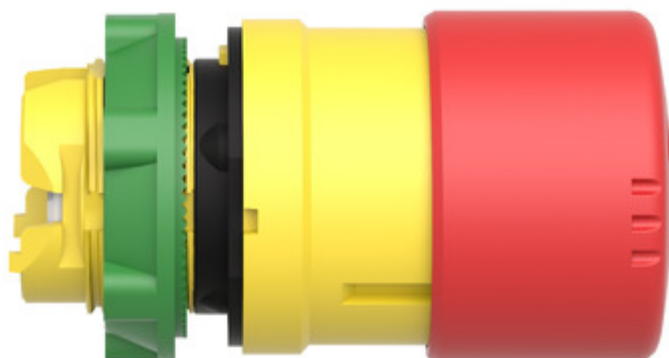

Image of product in real life situation

